

KEOPE GROUND



DESIGNED IN ITALY BY FRANCO PAGLIARINI



1.



2.

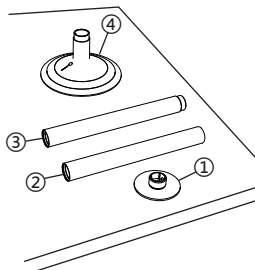

3.

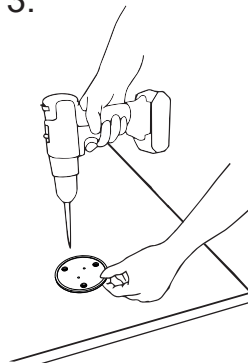

4.



5.

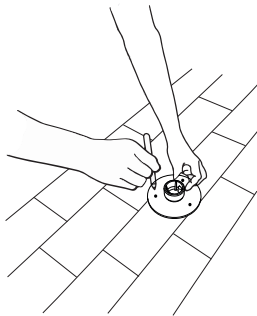

6.

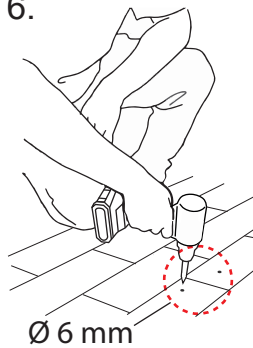

7.

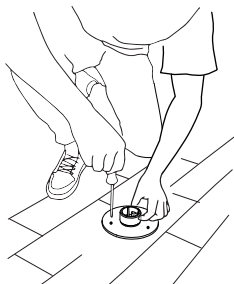

8.

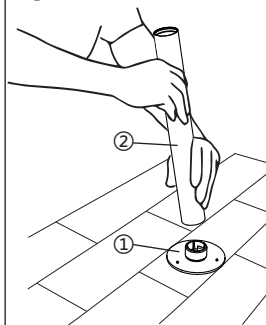

9.

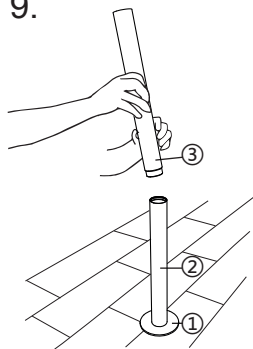

10.

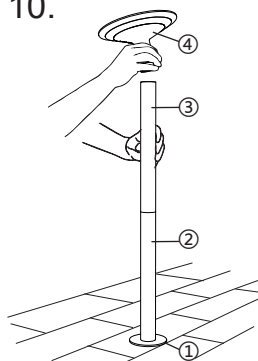

11.

> 3s

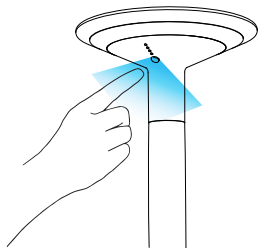

12.

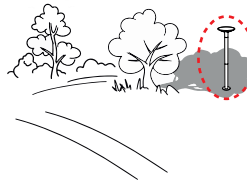
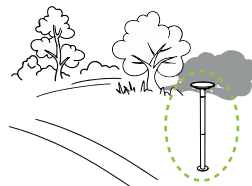
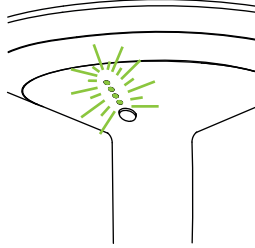

< 50LUX

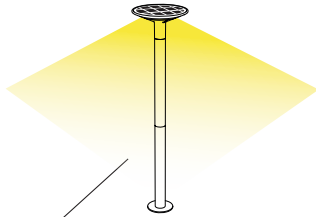

1h	30%			
2-4h	100%			
5h----	20%			

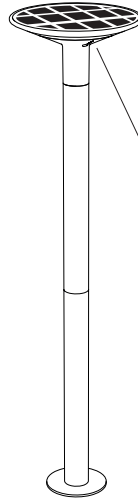

	100% ↔ 75%	
	75% ↔ 50%	
	50% ↔ 25%	
	25% ↔ 10%	
	10% ↔ 2%	
	< 2%	
	0%	

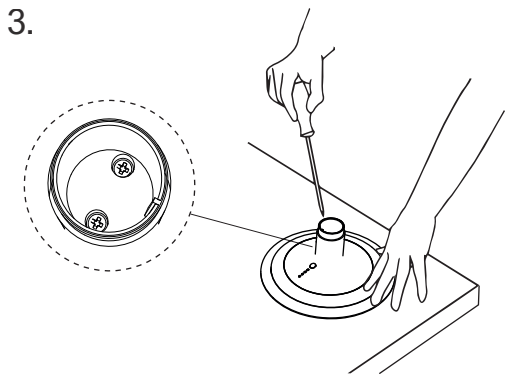
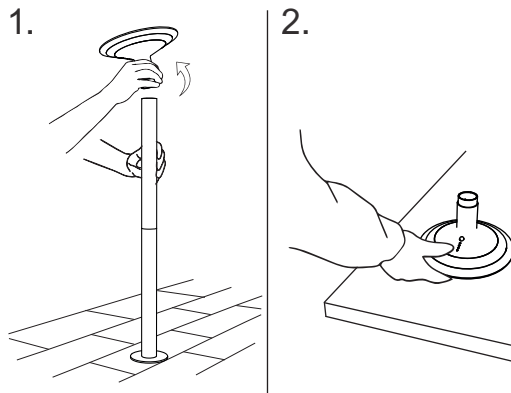
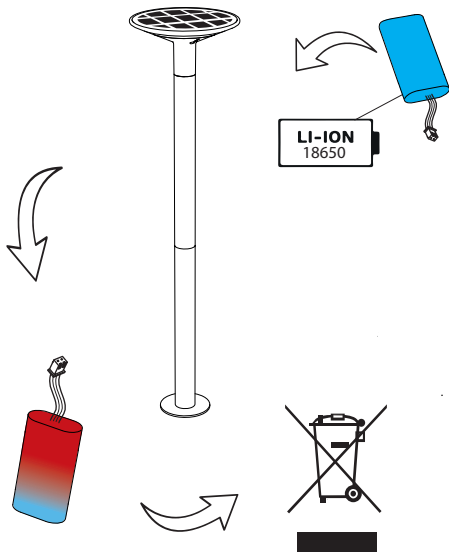
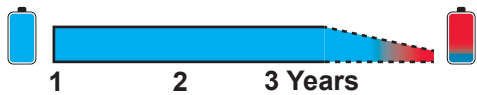

4.

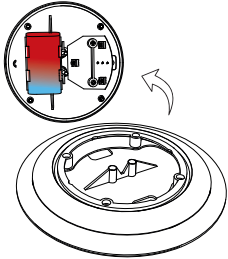

5.

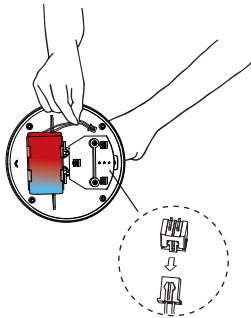

6.

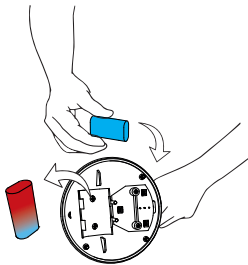

7.

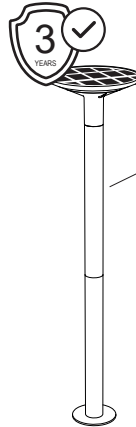
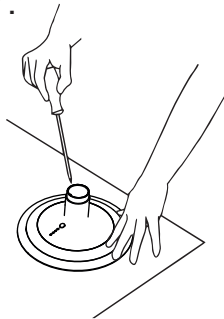

◆▲▲	IP65
☀	10-12h
💡	23-25h
Watt	3
LI-ION	4400 mAh
☀	3.5W 7V
💡	3000K
CRI	>80



info@zafferanoamerica.com